

# Strategic Environmental Assessments (SEAs)

LIMPOPO

PROVINCIAL & LOCAL GOVERNMENT

CONSULTATION WORKSHOP

## Identification of Strategic Power Corridors

Crescent Mushwana

Eskom, Grid Planning

*CSIR, Pretoria*

*6 November 2014*

# What is the Transmission Grid Network?

- The Transmission Grid Network is a system that is designed and constructed to deliver electrical power that is generated at one place to another place where it is consumed
- Voltage Level definitions/terminology in South Africa
  - Transmission is  $> 132\text{kV}$
  - Distribution is  $\leq 132\text{kV}$
  - Reticulation is  $\leq 22\text{kV}$
- One Transmission licence in South Africa – Eskom
- Many Distribution licences

# Role of the Transmission System Planner

- The function of the transmission system is to optimally and reliably transport the power from the source of generation to the location of the load
- Role of Transmission System Planner (TSP) flows from Eskom Transmission License issued by NERSA. TSP is required to conduct following activities for the *electricity supply industry*
  - To plan and augment the Transmission System
  - Planning to be in accordance with the Grid Code
  - Augmentation to take place subject to a connection agreement
  - Compliance is part of Eskom Transmission license
- **Network Code of SAGC specifies following for transmission planning**
  - Technical criteria
    - Voltage & thermal limits, reliability criteria, generation integration, etc.
    - Generator connection conditions (Protection, islanding, Governing , Black starting ,etc)
    - Connection conditions for distributors and end-use customers (Protection, Power factor, Fault levels, etc)
  - Planning Process
  - Investment Criteria

# The Different Development Plans

## Integrated Resource Plan

- The Department of Energy (Energy Planner) is accountable for the Country Energy Plan as per recently published regulations.
- The Country Plan is also termed the Integrated Resource Plan (IRP).
- The Integrated Resource Plan (IRP) is intended to drive all new generation capacity development.
- NERSA licences new generators according to this determination.

## Strategic Grid Plan

- The Strategic Grid Plan formulates long term strategic transmission corridor requirements
- Plan is based on range of generation scenarios, and associated strategic network analysis
- Horizon date is 20 years
- Updated every 2-3 years

## Transmission Development Plan

- Transmission Development Plan (TDP) presents transmission corridor requirements
- Plan covers a 10 year window
- Updated annually
- Indicates financial commitments required over 10 year period

# Transmission Development Plan (TDP) Overview

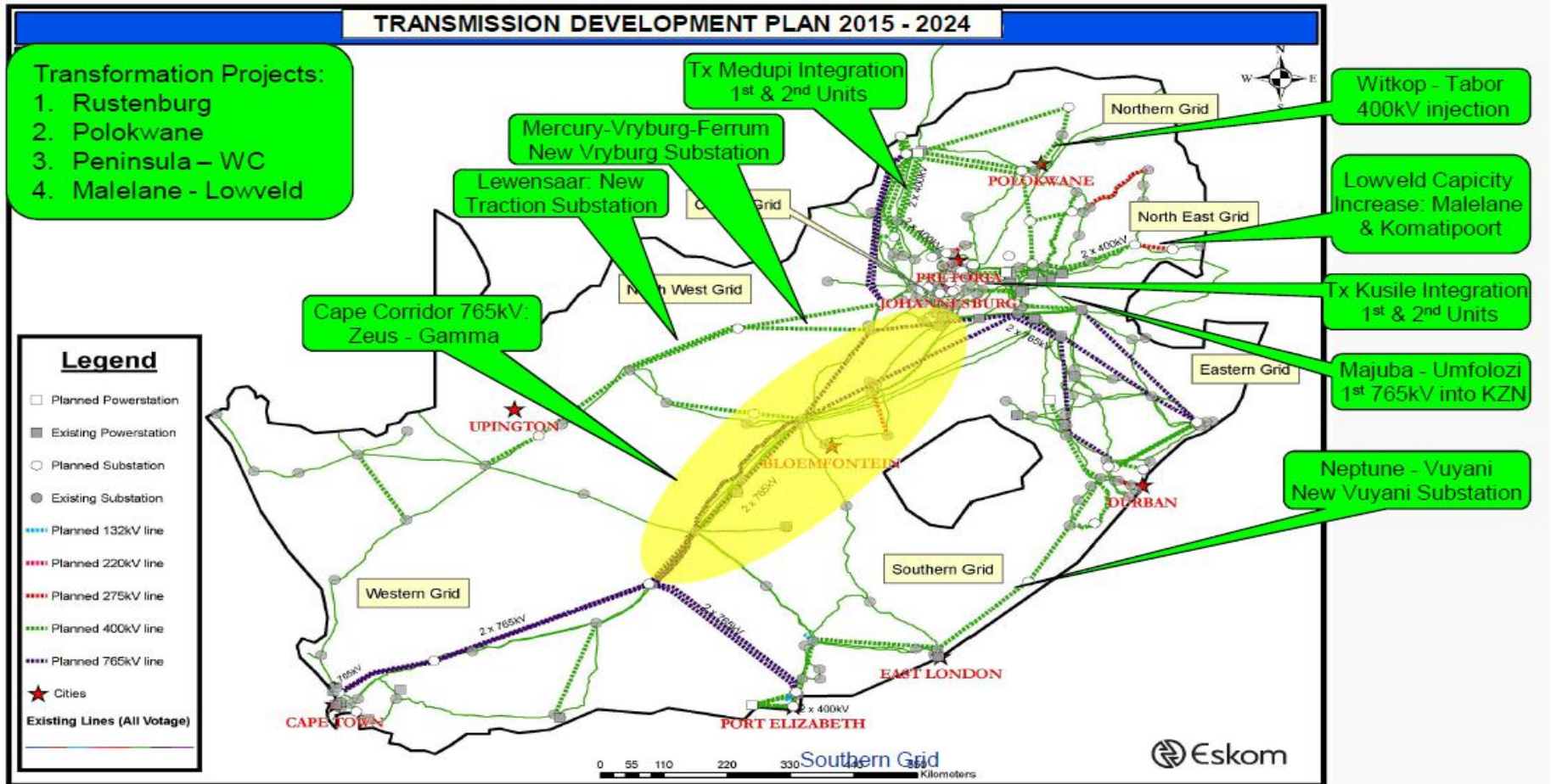

[http://www.eskom.co.za/Whatweredoing/TransmissionDevelopmentPlan/Pages/Transmission\\_Development\\_Plans.aspx](http://www.eskom.co.za/Whatweredoing/TransmissionDevelopmentPlan/Pages/Transmission_Development_Plans.aspx)

# STRATEGIC GRID PLAN

# The 2010 Integrated Resource Plan

Table 1 – IRP2010 Policy Adjusted Plan with Ministerial Determinations

	New build options								Committed					Non IRP
	Coal (PF, FBC, imports, own build)	Nuclear	Import hydro	Gas – CCGT	Peak – OCGT <sup>1</sup>	Wind	CSP	Solar PV	Coal	Other	DoE Peaker	Wind <sup>2</sup>	Other Renew.	Co-generation
	MW	MW	MW	MW	MW	MW	MW	MW	MW	MW	MW	MW	MW	MW
2010	0	0	0	0	0	0	0	0	380	260	0	0	0	0
2011	0	0	0	0	0	0	0	0	679	130	0	0	0	0
2012	0	0	0	0	0	0	0	300	303	0	0	400	100	0
2013	0	0	0	0	0	0	0	300	823	333	1020	400	25	0
2014	500	0	0	0	0	400	0	300	722	999	0	0	100	0
2015	500	0	0	0	0	400	0	300	1444	0	0	0	100	200
2016	0	0	0	0	0	400	100	300	722	0	0	0	0	200
2017	0	0	0	0	0	400	100	300	2168	0	0	0	0	200
2018	0	0	0	0	0	400	100	300	723	0	0	0	0	200
2019	250	0	0	237	0	400	100	300	1446	0	0	0	0	0
2020	250	0	0	237	0	400	100	300	723	0	0	0	0	0
2021	250	0	0	237	0	400	100	300	0	0	0	0	0	0
2022	250	0	1 143	0	805	400	100	300	0	0	0	0	0	0
2023	250	1 600	1 183	0	805	400	100	300	0	0	0	0	0	0
2024	250	1 600	283	0	0	800	100	300	0	0	0	0	0	0
2025	250	1 600	0	0	805	1 600	100	1 000	0	0	0	0	0	0
2026	1 000	1 600	0	0	0	400	0	500	0	0	0	0	0	0
2027	250	0	0	0	0	1 600	0	500	0	0	0	0	0	0
2028	1 000	1 600	0	474	690	0	0	500	0	0	0	0	0	0
2029	250	1 600	0	237	805	0	0	1 000	0	0	0	0	0	0
2030	1 000	0	0	948	0	0	0	1 000	0	0	0	0	0	0
<b>Total</b>	<b>6 250</b>	<b>9 600</b>	<b>2 609</b>	<b>2 370</b>	<b>3 910</b>	<b>8 400</b>	<b>1 000</b>	<b>8 400</b>	<b>10133</b>	<b>1722</b>	<b>1020</b>	<b>800</b>	<b>325</b>	<b>800</b>



2011 Determinations



2012 Determinations



Eskom commitments (pre IRP)

Notes: 1. OCGT is seen as natural gas in the determination

2. Includes Sere (100MW)

# Study Methodology – Design Philosophy

## Layer model for substation requirements and network development

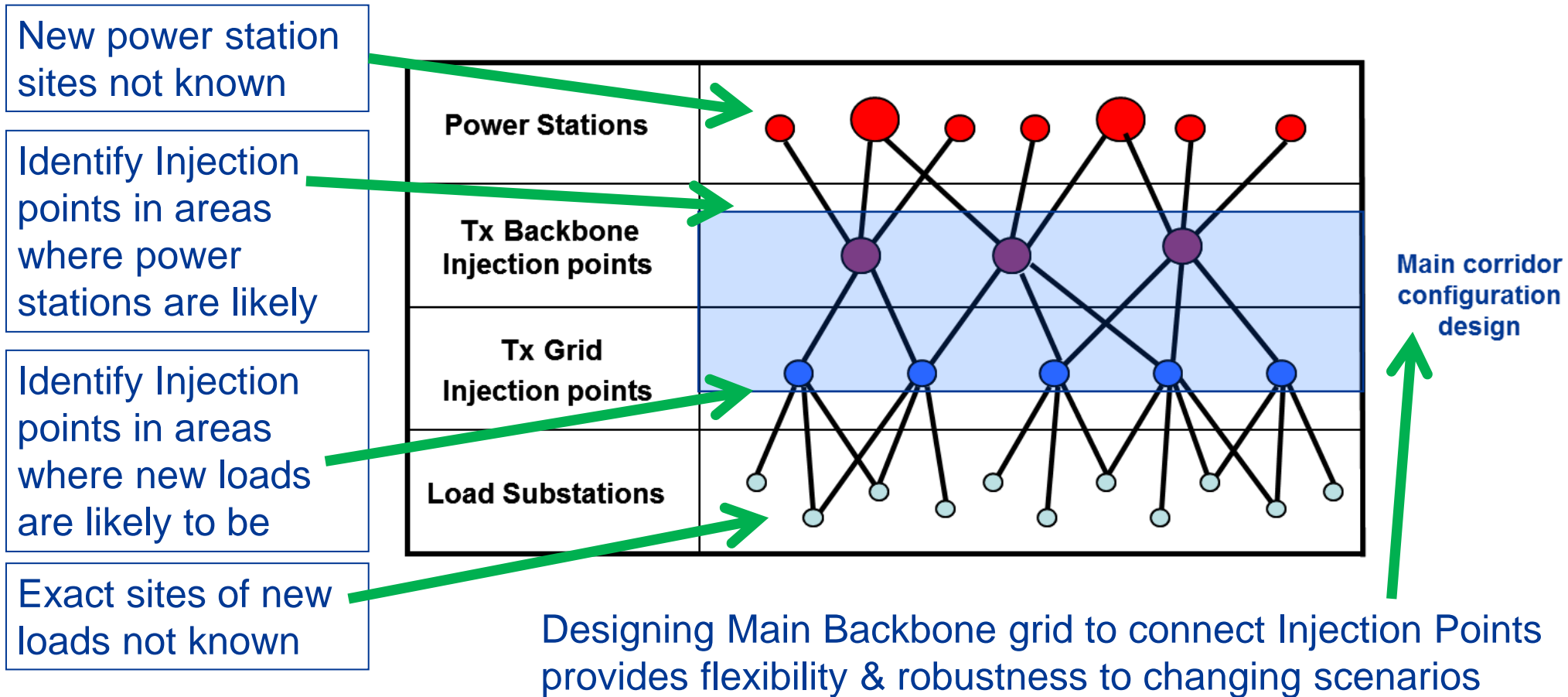



# The Strategic 2040 Network Study

- Eskom has updated the 2030 strategic grid study to 2040
- Why 2040 - Most of the existing coal power stations in Mpumalanga will be decommissioned – what is the impact on the grid?
- Major difference between 2030 & 2040 studies is consultation with external stakeholders (such as renewable energy associations) for the development of the new generation scenarios
- 2010 IRP is the base scenario - however there is uncertainty on the location and actual performance of the generation sources, e.g. wind
- Three Generation Scenarios were selected

# Proposed three Generation Scenarios

- **The IRP 2010 base Scenario (BASE IRP)**
  - IRP will be extended to 2040
  - Coal will be fixed at 2030 level
  - Balance in similar ratio to 2030 mix
- **Increased Renewables Scenario (GREEN)**
  - Replace nuclear component with RE base generation equivalent
  - CSP (with storage)/ Wind with CCV of 30% / Natural Gas
- **Increased Imports Scenario (IMPORT)**
  - Double imported power by 2030
  - Reduce coal & nuclear

# Important Generation Assumptions

- For 2030 to 2040 will replace decommissioned coal with new coal – this will not increase coal component – however location will be different
- Note that this is 17 GW of decommissioned coal generation
- Wind is given a 30% Capacity Credit Value (contribution at time of system peak) for the scenarios – based on the Wind Capacity Credit Study done in 2010 and IRP 2010 assumptions
- In BASE IRP scenario – will test impact on networks if wind output is only at 10% and if as high as 60%
- For GREEN scenario will replace nuclear with “base RE equivalent” as follows:
  - 60% CSP with storage
  - 25% equivalent of Wind (with CCV of 30%)
  - 15% of OCGT & CCGT

# Mapping the Demand and Generation

- First the Demand is allocated to each Municipal Area and then summated by province to get the total Load Demand for each province
- The Bars represent the relative Demand for 2011, 2020, 2030 and 2040 with the 2040 figure shown

- Secondly the Generation is allocated to each Municipal Area and then summated by province to get the total Generation for each province for each Generation Scenario
- The Bars represent the relative Generation for 2011, 2020, 2030 and 2040 with the 2040 figure shown

LOAD GROWTH BY 2040 PER PROVINCE  
(Maximum Demand in MW)

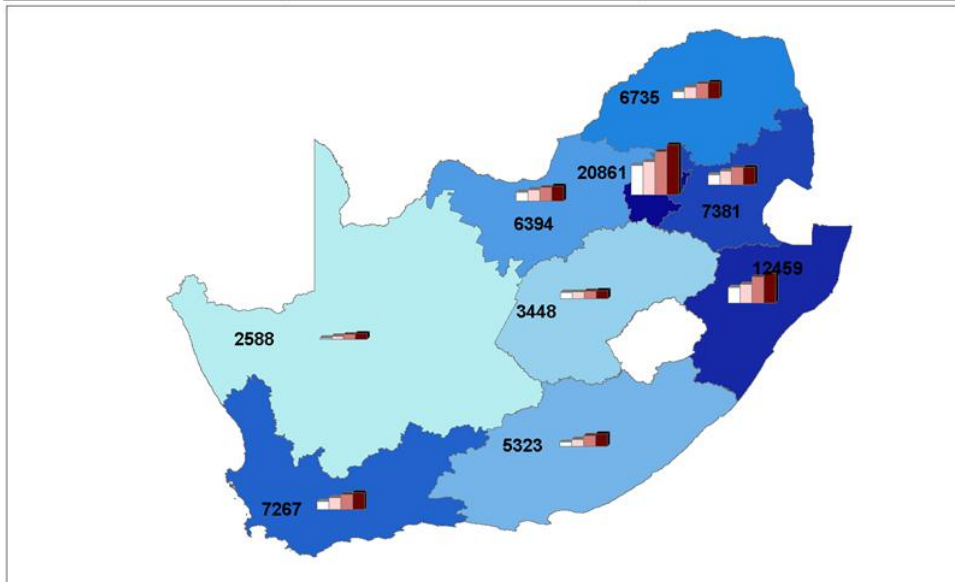

GENERATION DEVELOPMENT FOR SCENARIO A (BASE IRP)  
(Maximum Demand in MW)

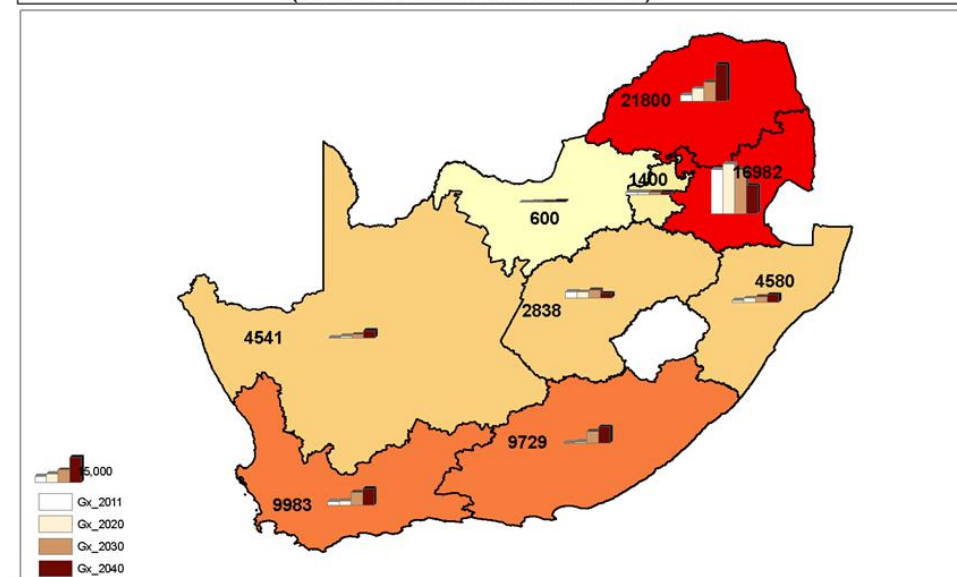

# Mapping the Demand Balance up to 2040

- The Supply and Demand Balance value is then calculated for each Generation Scenario for each year to 2040 to determine the change over this period
- The 2011, 2020, 2030 and 2040 scenarios are presented in the report to illustrate the change over each decade
- The Bars represent the relative Demand Balance for 2011, 2020, 2030 and 2040 with the 2040 figure shown for Scenario A in this case
- All three Generation Scenarios can be mapped and compared to show the differences between the scenarios over time

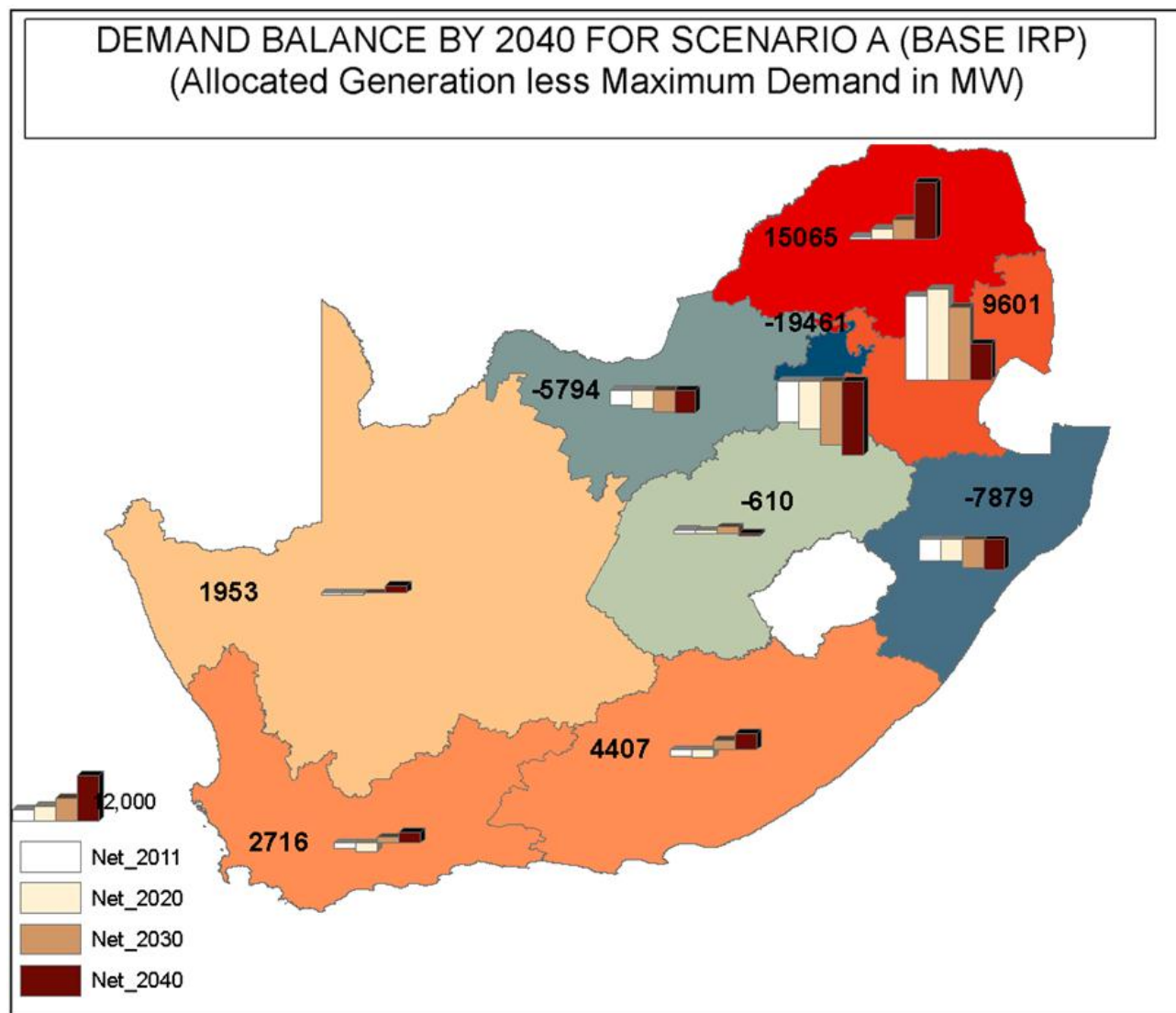

# Comparing Demand Balances for each Generation Scenario

## DEMAND BALANCE PROGRESSION FOR EACH SCENARIO (Installed Generation less Maximum Demand in MW)

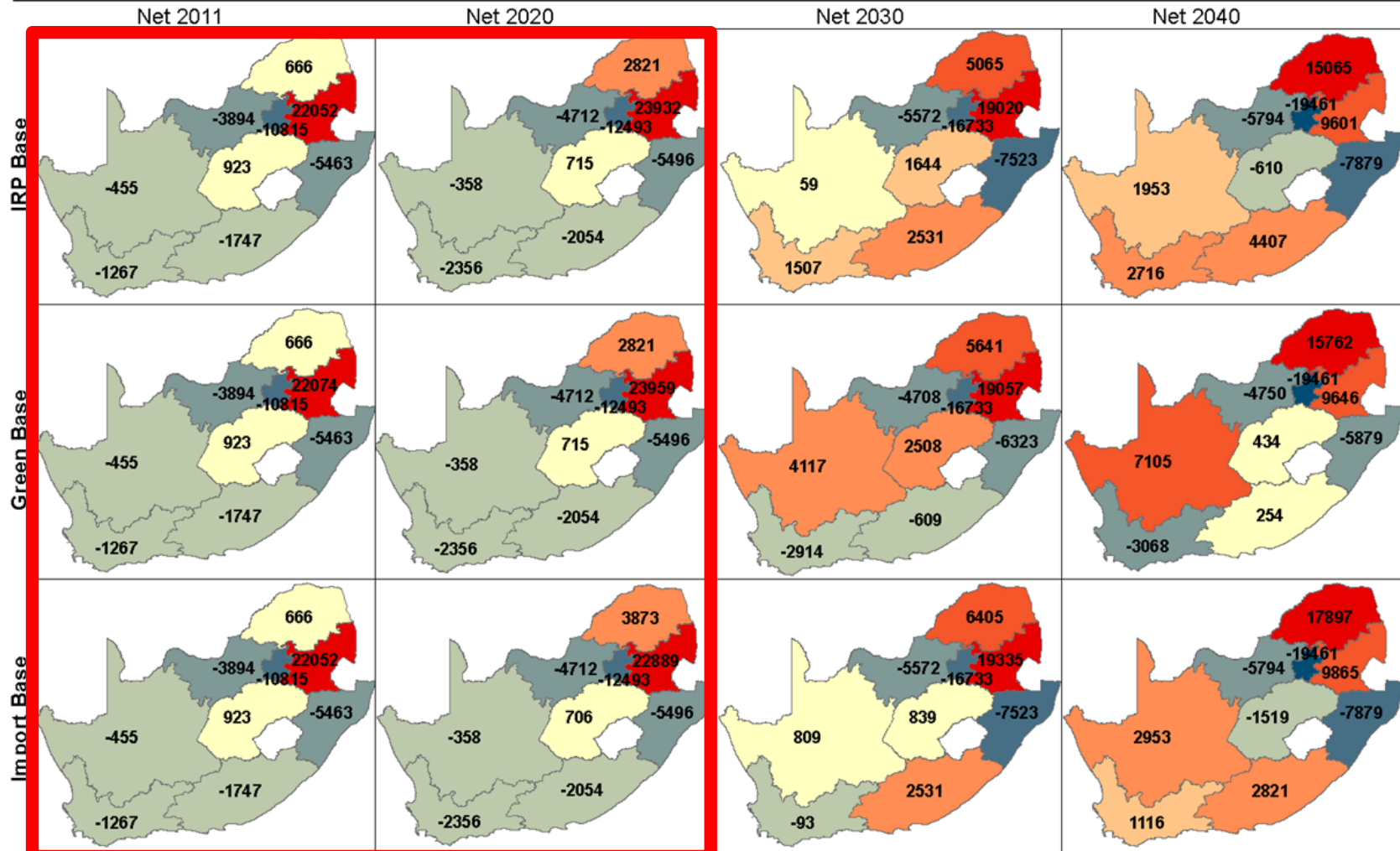

*Marginal scenario difference for the TDP period*

# Impact of variance of wind output

- Large installed wind generation can lead to large variation in wind output
- Considered 30% & 60% output of area totals – assumed even spread
- Also considered impact of wind patterns – wind can blow from west to east zones (ABC) or east to west (CBA)
- High wind at Low Load can also impact on excess or deficit power values in areas

Wind Zones for estimating wind pattern impact

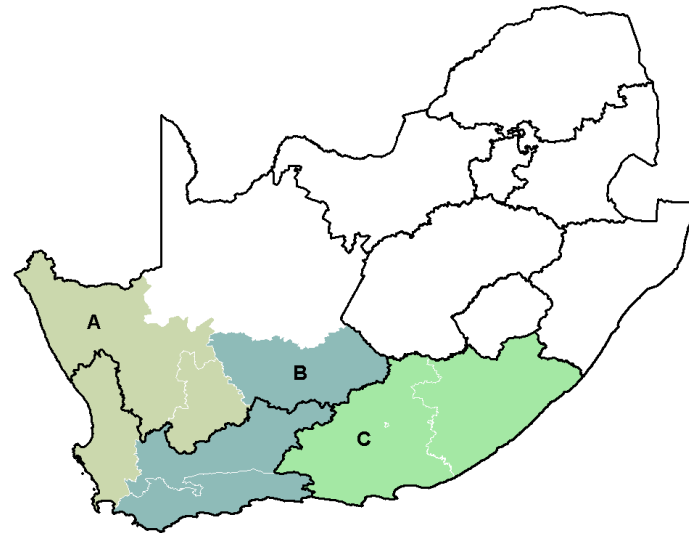

- Considered variations in wind patterns at *Peak Load* and *Low Load* to determine **the range between maximum and minimum power excess or deficit** for each scenario
- Identified the largest range variations under all scenarios to highlight areas of highest risk



# MAX & MIN DEMAND BALANCE PROGRESSION CONSIDERING ALL SCENARIOS (Allocated Generation less Maximum Demand in MW)

2011

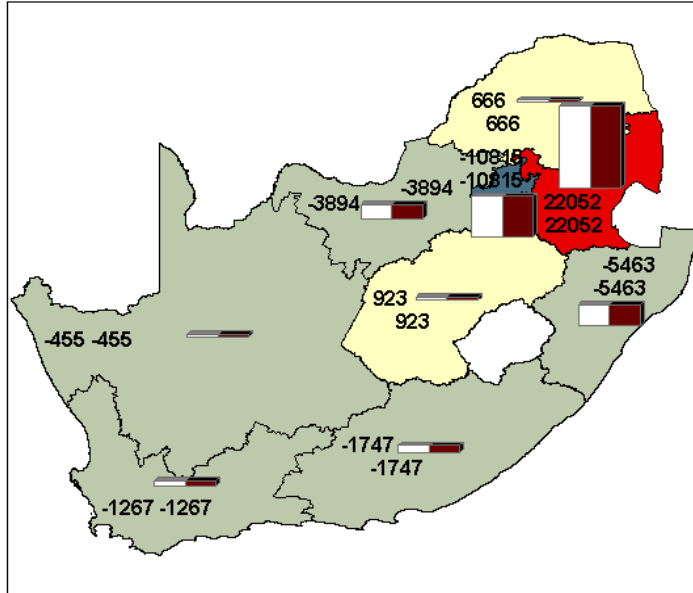

2030

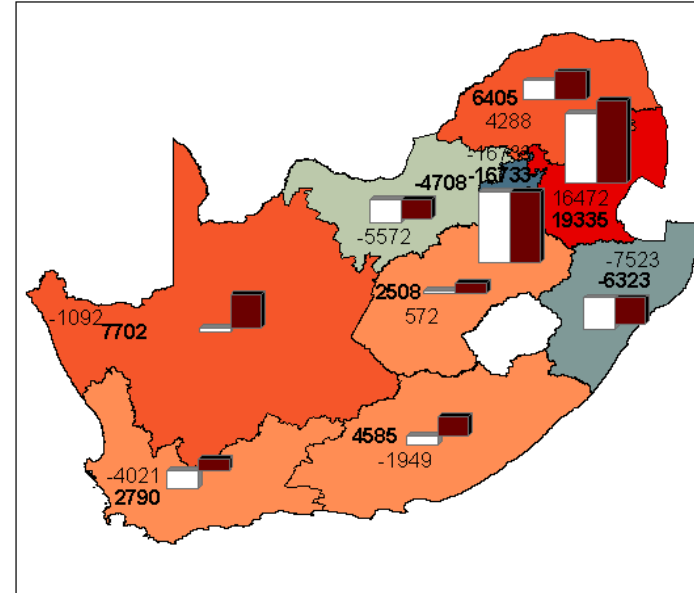

2020

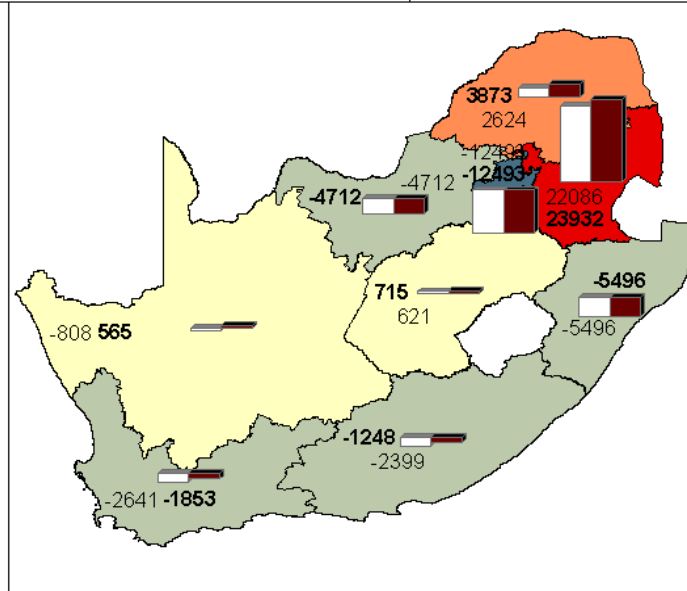

2040

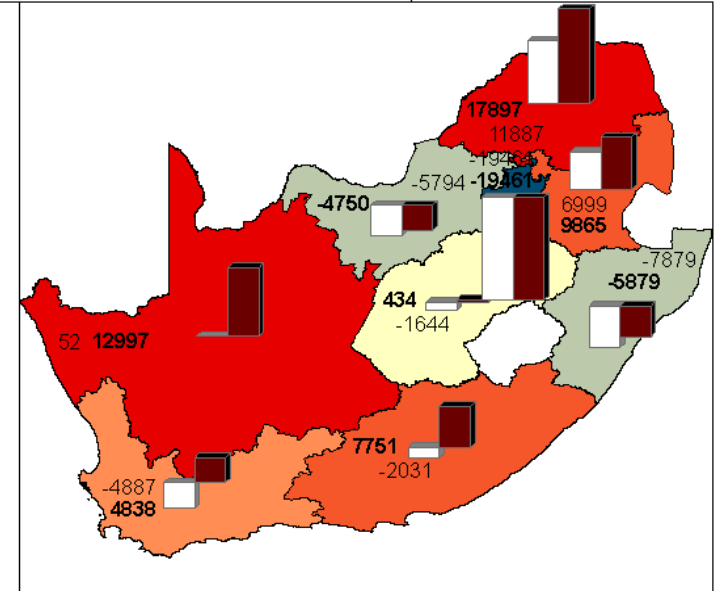

## Legend

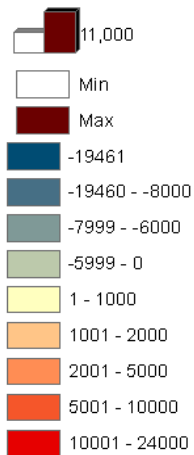



# Transmission Centroid Network

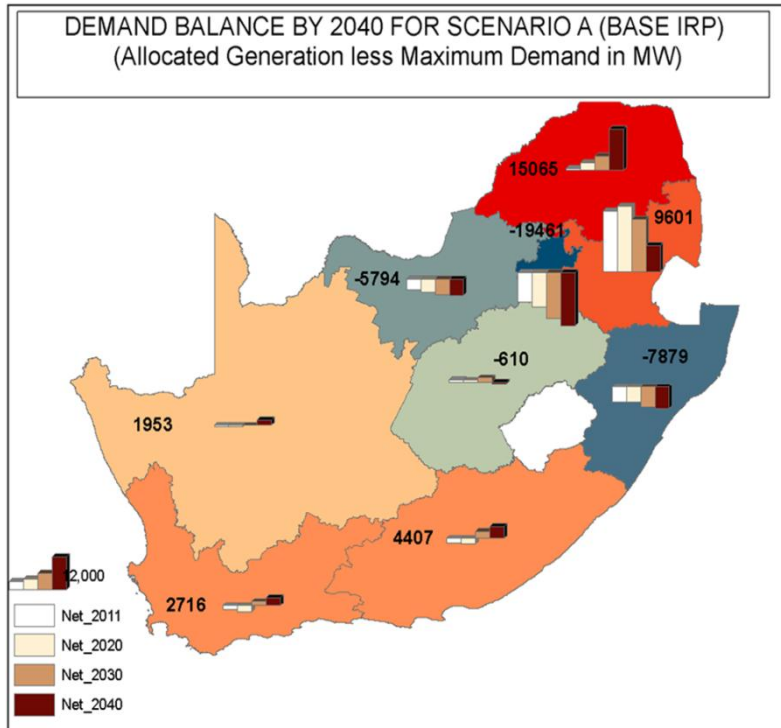

Existing network ignored and a “relative impedance” copper plate assumed over country to determine preferred least resistance power flows – lowest losses

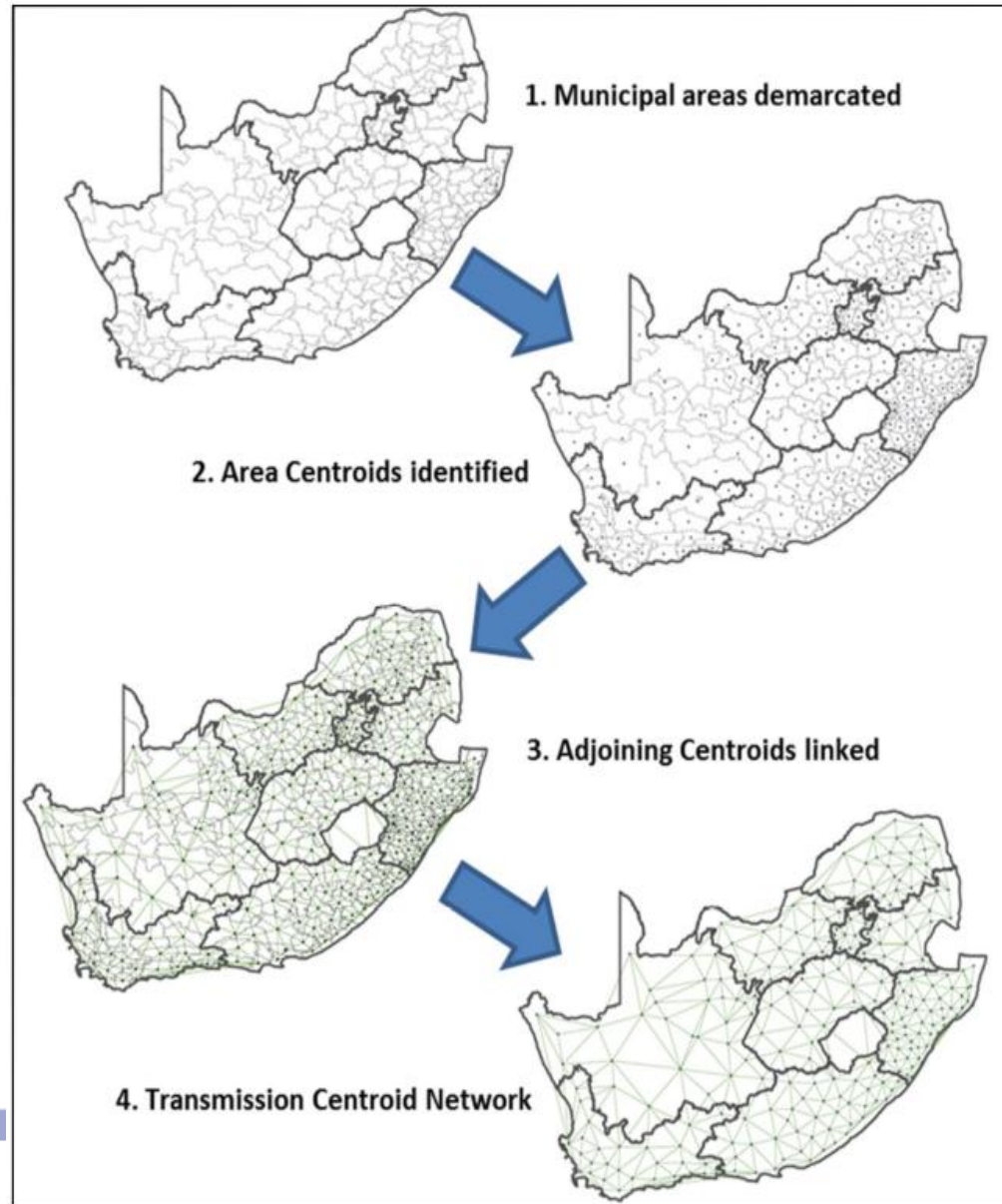

# Analysis of Scenarios

2040 Peak Load			Max Scenario 4	Max Scenario 3									Max Scenario 1							Max Scenario 2
Gen Scenario --- Province	GREENW30ABC	GREENW30Base	GREENW30CBA	GREENW60ABC	GREENW60Base	GREENW60CBA	IMPORTW30ABC	IMPORTW30Base	IMPORTW30CBA	IMPORTW60ABC	IMPORTW60Base	IMPORTW60CBA	IRPW30	IRPW30ABC	IRPW30CBA	IRPW60ABC	IRPW60Base	IRPW60CBA		
Eastern Cape	1950	254	4949	2031	2376	5314	1364	2821	5925	1304	4217	6159	4407	2950	7511	2896	5809	7751		
Free State	434	434	434	94	94	94	1519	1519	1519	1644	1644	1644	610	610	610	835	835	835		
Gauteng	19461	19461	19461	19461	19461	19461	19461	19461	19461	19461	19461	19461	19461	19461	19461	19461	19461	19461		
KwaZulu-Natal	5879	5879	5879	5879	5879	5879	7879	7879	7879	7879	7879	7879	7879	7879	7879	7879	7879	7879		
Limpopo	15762	15762	15762	11887	11887	11887	17897	17897	17897	15296	15296	15296	15065	15065	15065	12504	12504	12504		
Mpumalanga	9601	9601	9601	6999	6999	6999	9865	9865	9865	8090	8090	8090	9601	9601	9601	7881	7881	7881		
North West	4750	4750	4750	4750	4750	4750	5794	5794	5794	5794	5794	5794	5794	5794	5794	5794	5794	5794		
Northern Cape	9532	7105	4229	12997	9982	7082	4557	2953	1052	6848	4855	2938	1953	3557	52	5848	3855	1938		
Western Cape	3291	3068	4887	142	1250	1288	968	1116	87	3238	2319	2293	2716	2568	1513	4838	3919	3893		
Gen Total	70661	66315	69953	64242	62678	62755	69306	69306	69479	69555	69555	69555	67486	67486	67486	67936	67936	67936		

# Inter-Province Power Transfers for IRP W60 CBA 2040 scenario

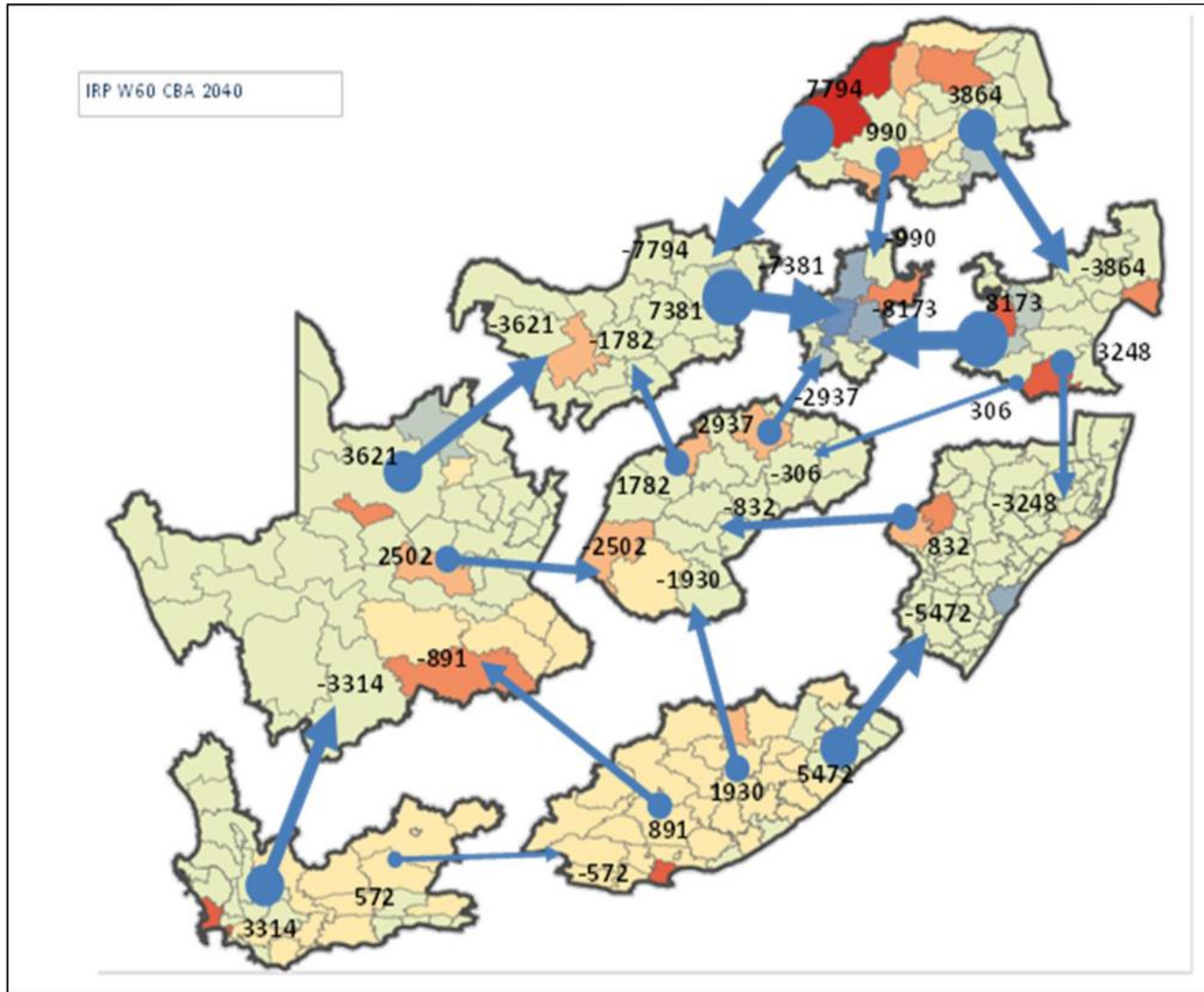



# Inter-Province Power Transfers for 4 representative scenarios

## Import W30 CBA 2040

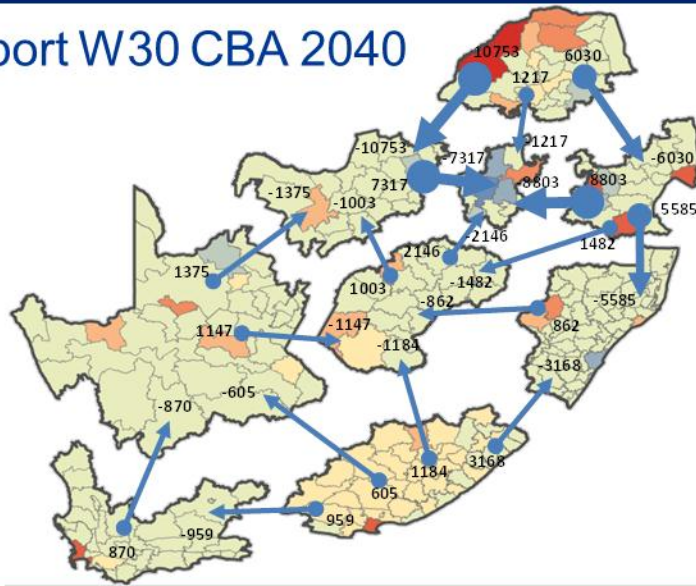

## IRP W60 CBA 2040

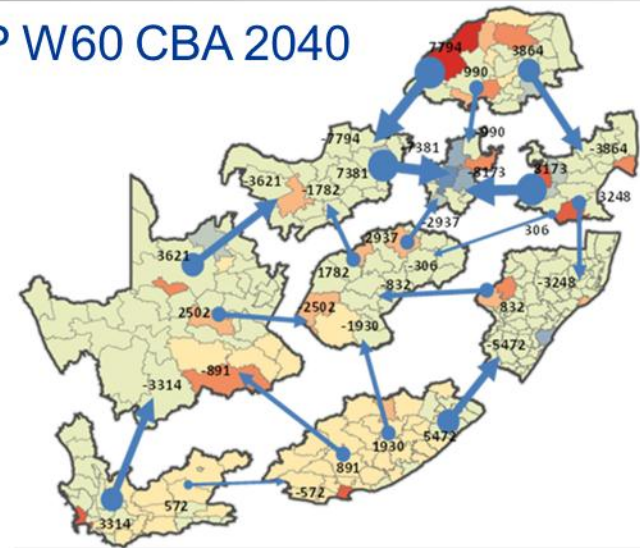

## Green W60 ABC 2040

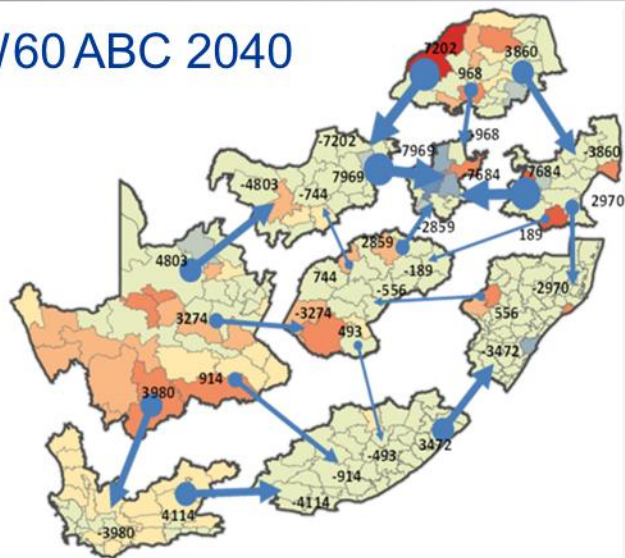

## Green W30 CBA 2040

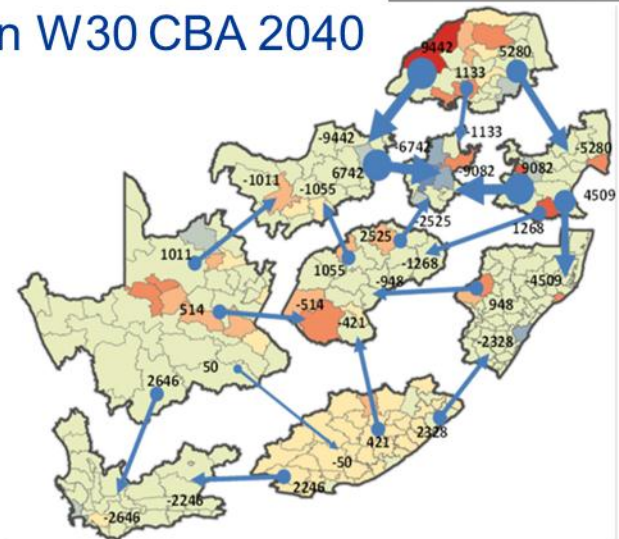

# 2040 Strategic Grid Planning – Generation Spatial Allocation

MAXIMUM GENERATION BY 2040  
ALL SCENARIOS

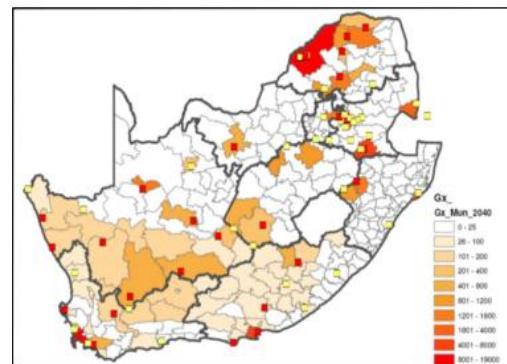
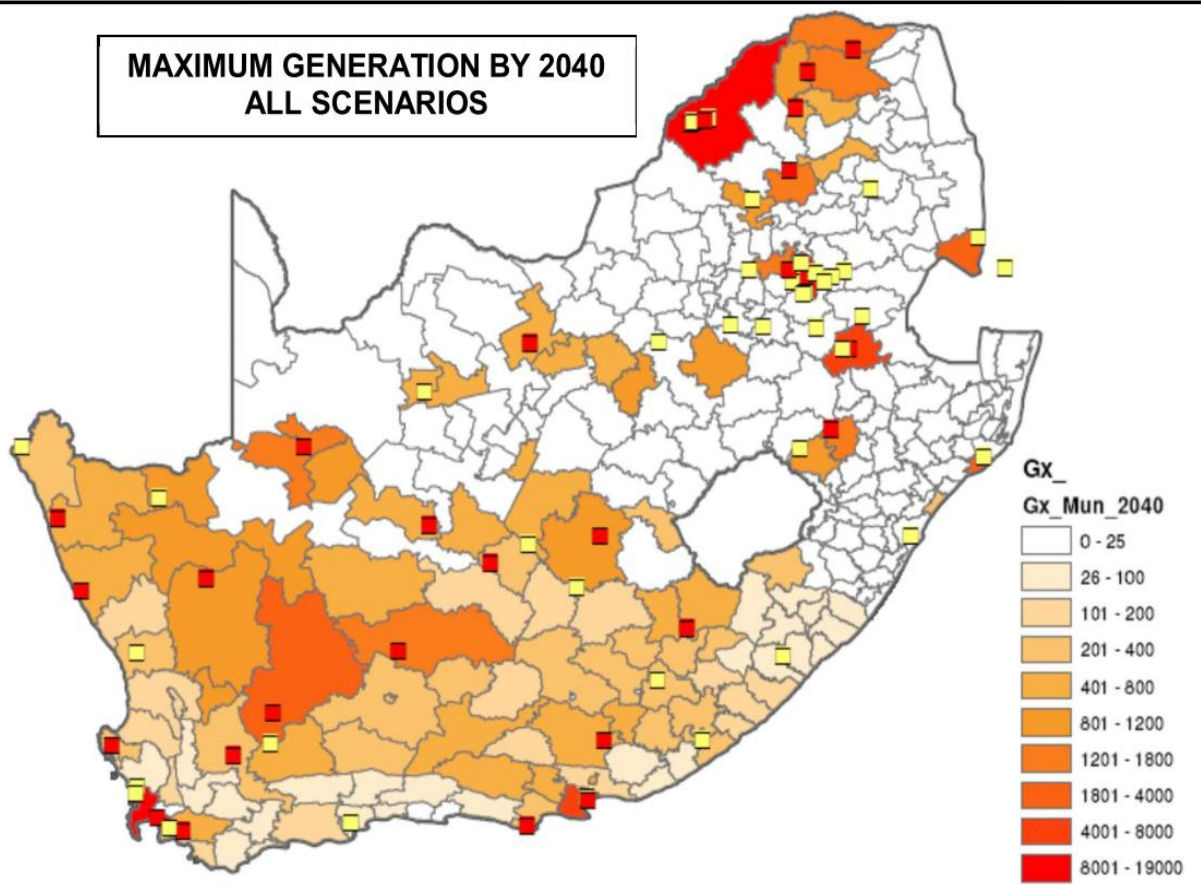

Base IRP  
Scenario

Even  
Spread of  
Wind

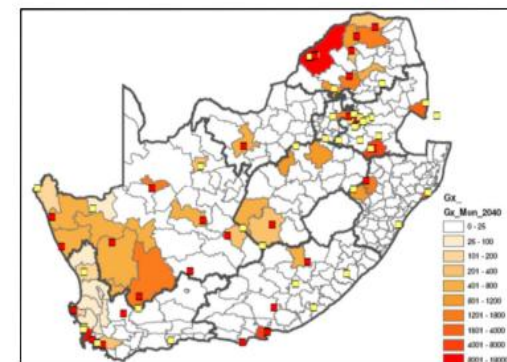

West to  
East  
Pattern of  
Wind

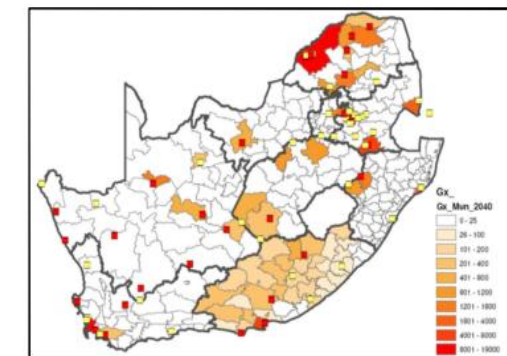

East to  
West  
Pattern of  
Wind



# 2040 Strategic Grid Planning - Load Spatial Allocation

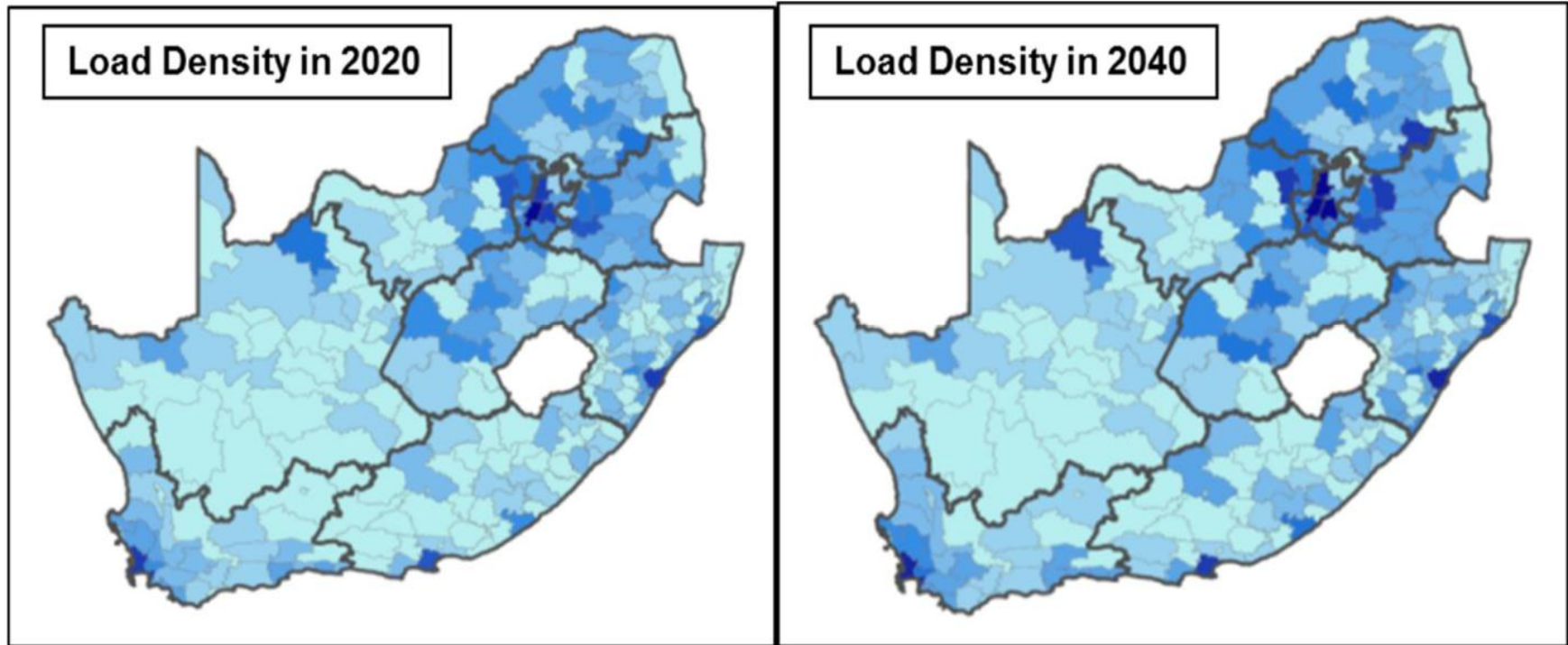

There is no significant change in the location of the major load centres from 2020 to 2040.

The existing load centres merely get larger and denser

Load in the Steelpoort/Lydenburg area grows rapidly at the expense of Rustenburg

# 2040 Strategic Grid Planning – Consolidation of Inputs

## National Planning Scenario's

Supply options

Spatial & Economic impact

Demand options

Spatial & Economic impact

## Common Least regret Spatial Development Plans, EIA & Servitudes

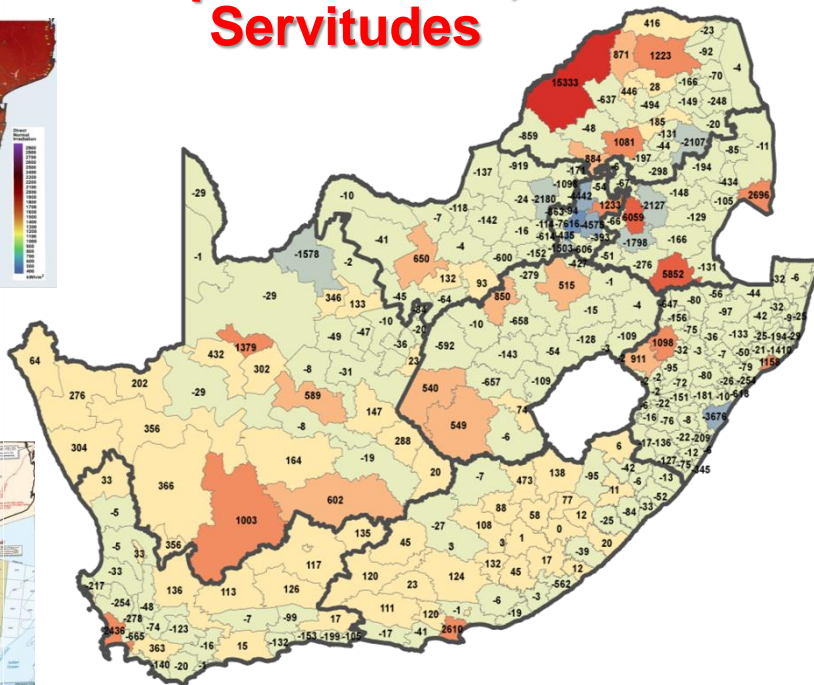
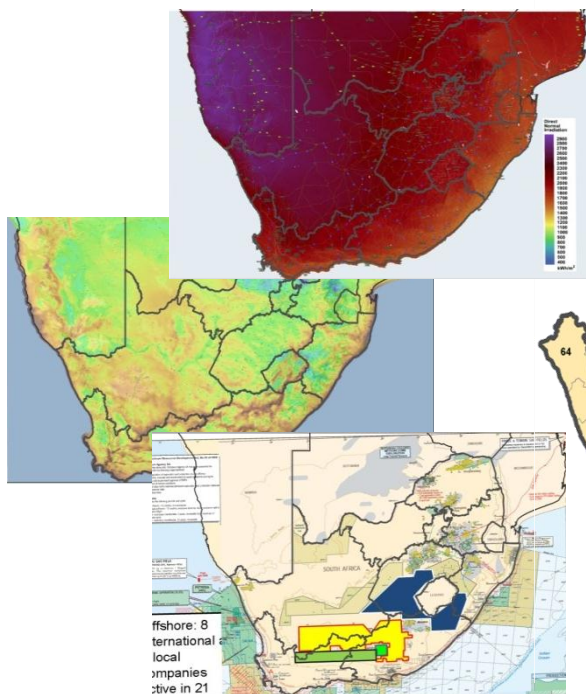

# 2040 Strategic Grid Planning – SEA Corridors

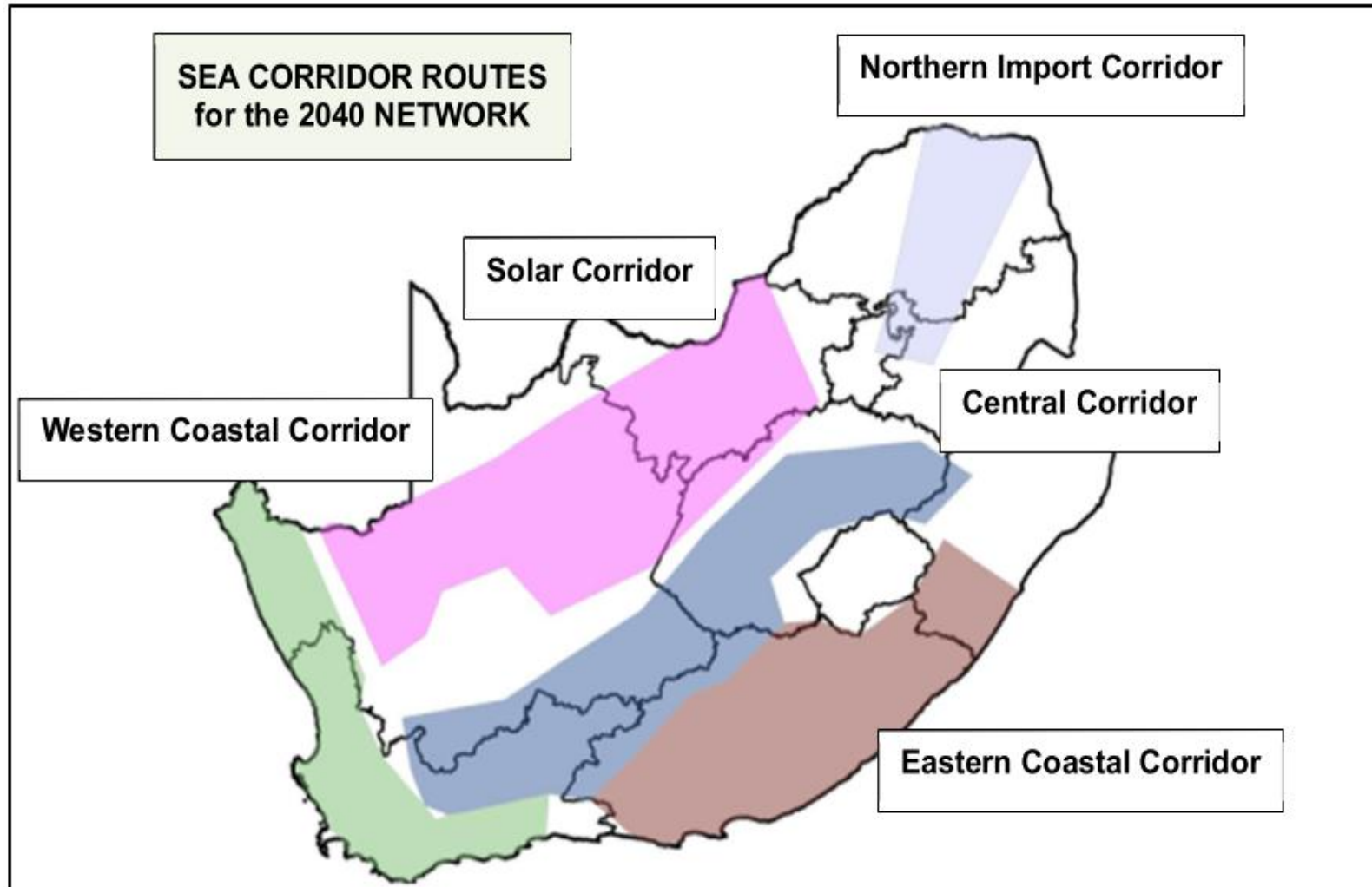

Analysis of the inter-province power flows across the generation scenarios and loading conditions start to indicate where the power flows concentrates under all scenarios.

Five major corridors were identified for the future strategic development of the Tx Grid



# 2040 Strategic Grid Planning – Correlation with Investor Interest

SEA - Wind and Solar Preferred Location

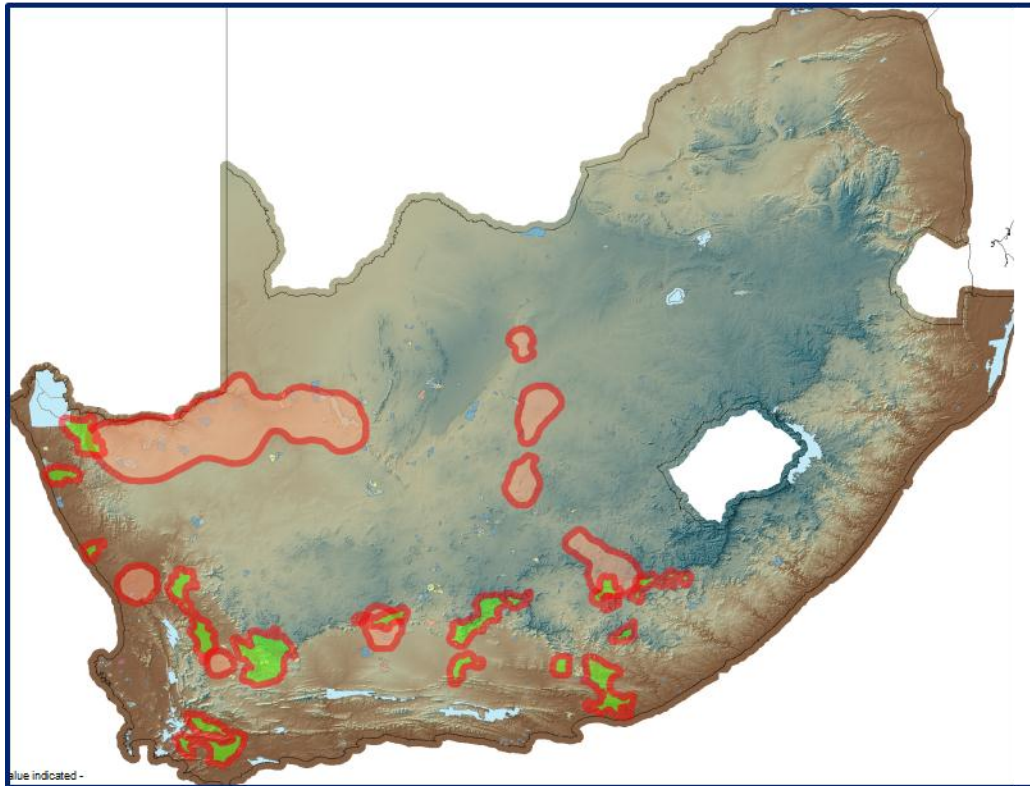

Developers - Solar Preferred Location

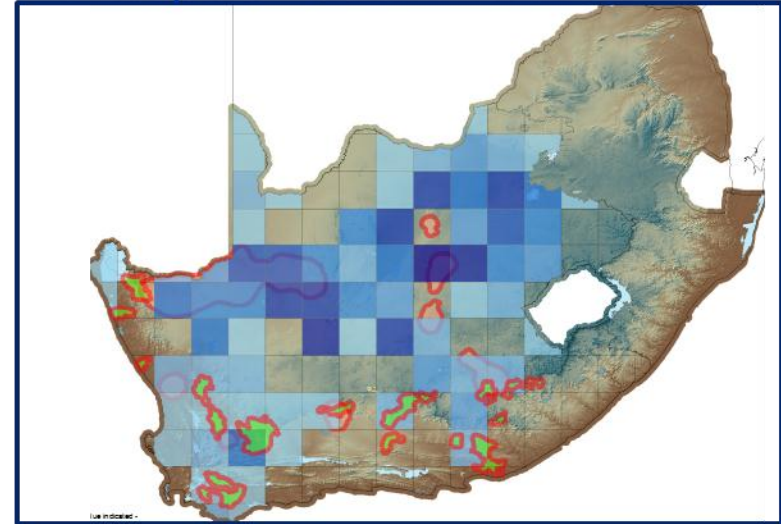

Developers – Wind Preferred Location

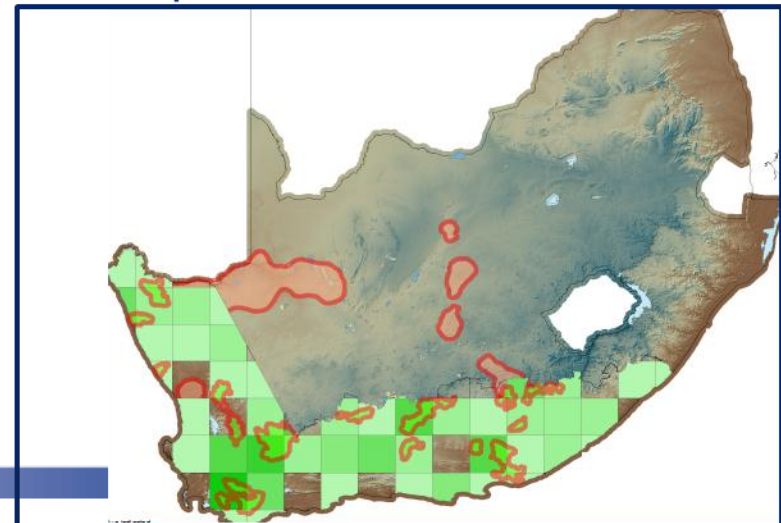

# 2040 Strategic Grid Planning – National Corridors

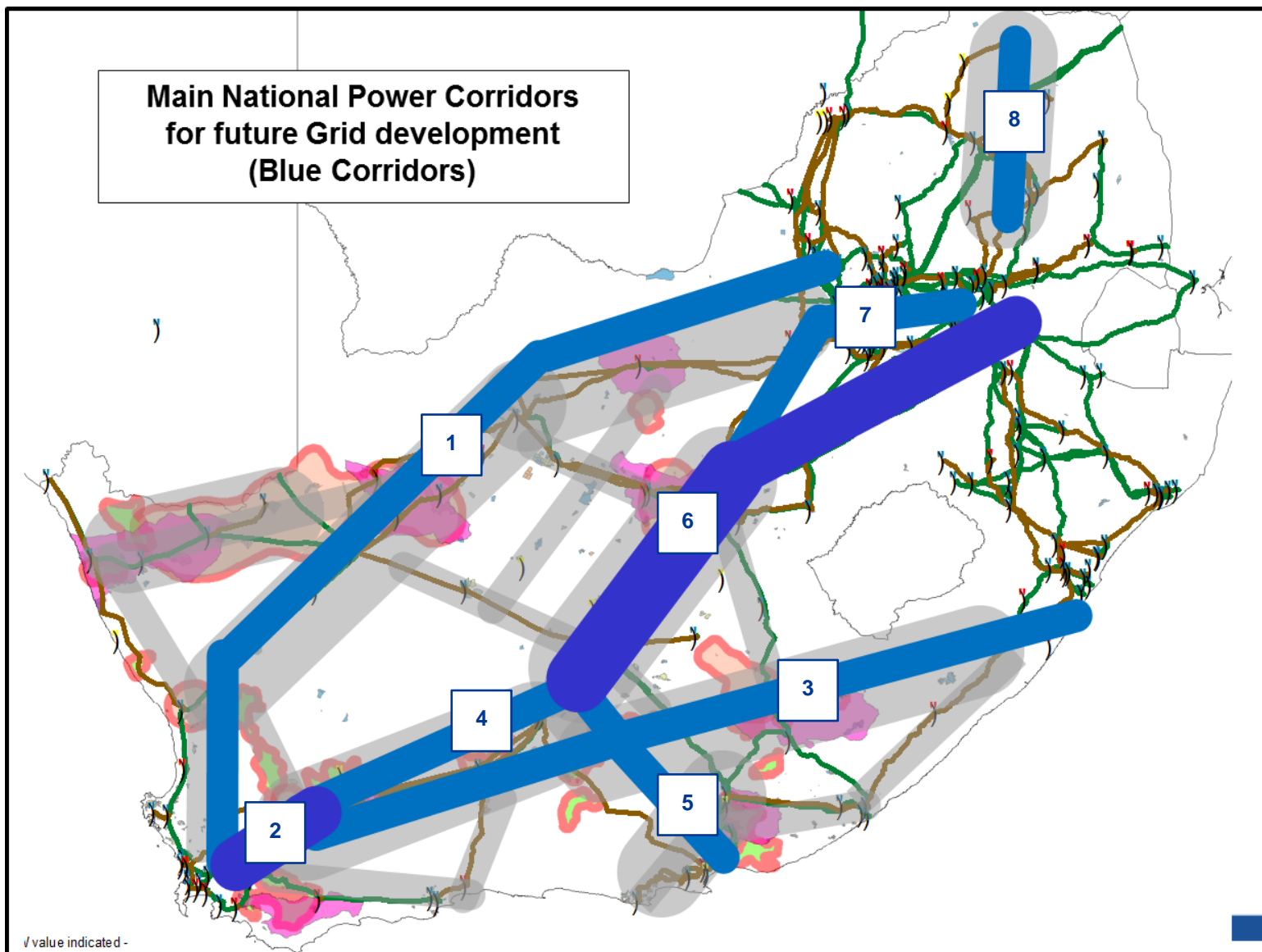

The “**Local**” power corridors were identified to collect new generation and supply load centres within the provinces. (Shown in Grey)

These can then be grouped into or linked to a number of “**National**” power corridors to move the generation around the country to the load centres under various conditions and scenarios. (Shown in Blue)





# SGP Tx 2040 Study Corridor Overview

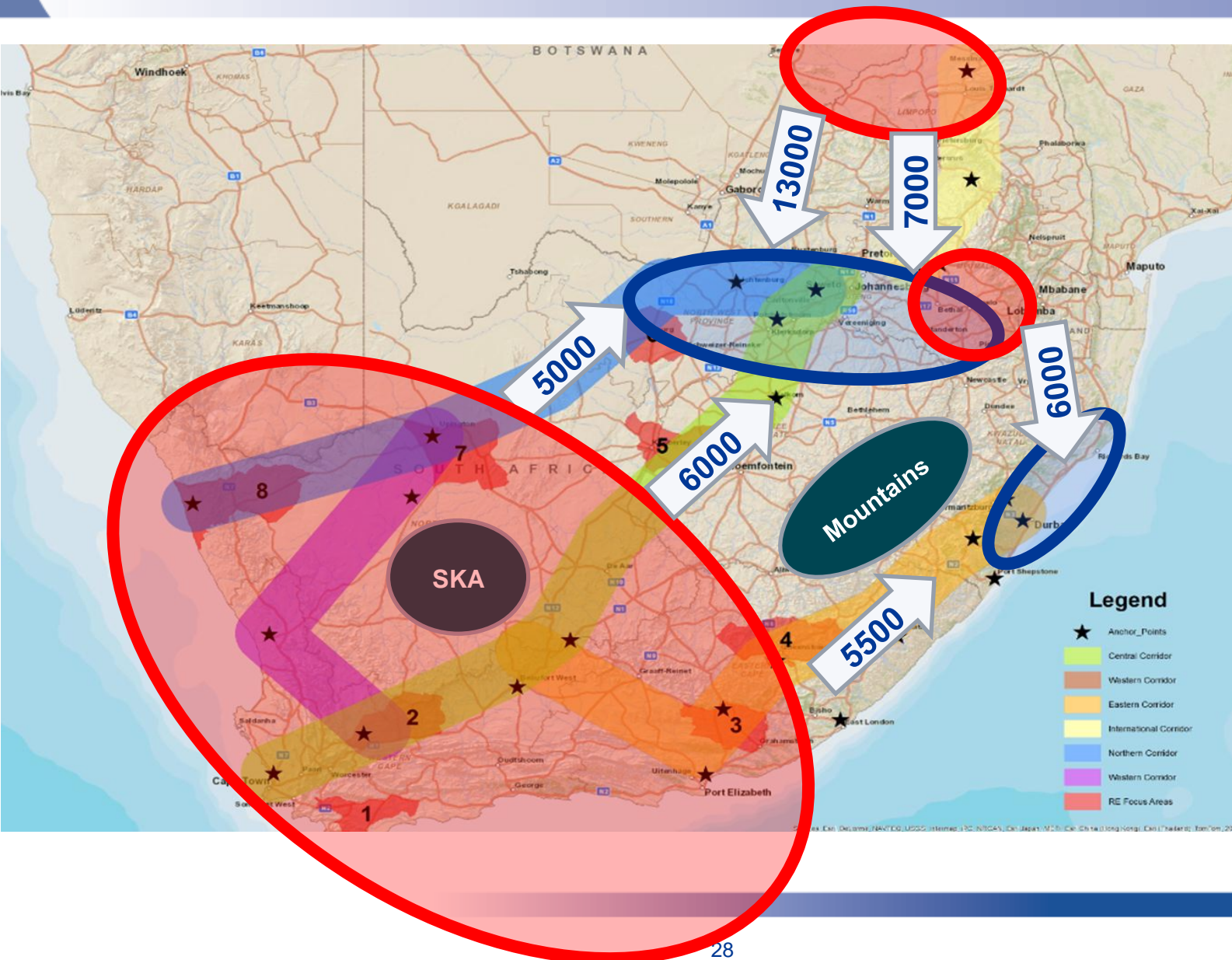

# Impact of Provincial & Local Govt. Development Plans

- The 5 SEA Corridor Routes based on available information and known expectations.
- Provincial & Local Govt. Development Plans need to recognise these corridors and accommodate them.
- More importantly can your Development Plans be “seen” in the power corridors – i.e. are your needs been addressed?
- Objective of Workshop is to discuss to see how can power corridors support the local development plans and ensure the Transmission & Distribution electrical networks are accounted for into the future.



**THANK YOU**